

Service
Service
Service

Service Manual

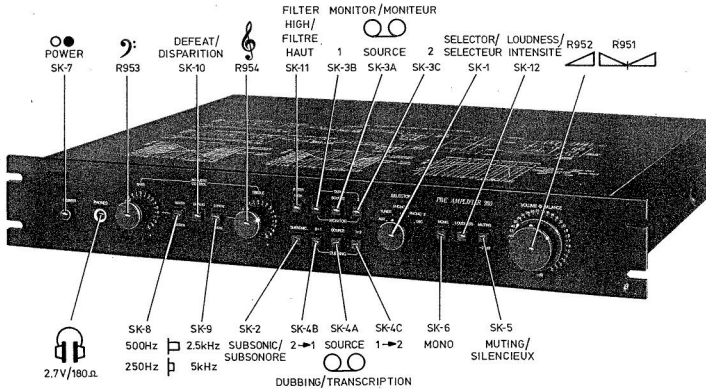

16258A12

(GB)

Input signal for 2 V per channel at 1 kHz

Phono 1,2	: 2 mV ± 0.25 mV/40 kΩ
Mic	: 1.7 mV ± 0.25 mV/47 kΩ
Aux, tuner	: 240 mV ± 0.25 mV/10 kΩ
Recorder 1,2	: 210 mV ± 0.25 mV/15 kΩ

For more detailed technical specifications please consult commercial documentation.

(F)

Signal d'entrée à 2 V par canal à 1 kHz

Phono 1,2	: 2 mV ± 0.25 mV/40 kΩ
Mic	: 1.7 mV ± 0.25 mV/47 kΩ
Aux, tuner	: 240 mV ± 0.25 mV/10 kΩ
Sortie magnéto 1,2	: 210 mV ± 0.25 mV/15 kΩ

Pour l'obtention de données techniques plus détaillées veuillez consulter la Documentation commerciale.

(I)

Segnale d'ingresso per 2 V per canale a 1 kHz

Phono 1,2	: 2 mV ± 0.25 mV/40 kΩ
Mic	: 1.7 mV ± 0.25 mV/47 kΩ
Aux, tuner	: 240 mV ± 0.25 mV/10 kΩ
Recorder 1,2	: 210 mV ± 0.25 mV/15 kΩ

In modo da ottenere dati tecnici più particolareggiati, vi preghiamo di riferirvi alla documentazione commerciale.

(DK)

Inputsignal for 2 V pr. kanal ved 1 kHz

P.U. 1,2	: 2 mV ± 0.25 mV/40 kΩ
Mic	: 1.7 mV ± 0.25 mV/47 kΩ
Aux, tuner	: 240 mV ± 0.25 mV/10 kΩ
Båndoptager 1,2	: 210 mV ± 0.25 mV/15 kΩ

For mere detaljerede specifikationer, se tekniske datablade.

(NL)

Ingangssignaal voor 2 V per kanaal bij 1 kHz

Phono 1,2	: 2 mV ± 0.25 mV/40 kΩ
Mic	: 1.7 mV ± 0.25 mV/47 kΩ
Aux, tuner	: 240 mV ± 0.25 mV/10 kΩ
Rec. 1,2	: 210 mV ± 0.25 mV/15 kΩ

Voor meer uitgebreide technische specificaties gelieve de commerciële documentatie te raadplegen.

(D)

Eingangssignal für 2 V je Kanal bei 1 kHz

P.U. 1,2	: 2 mV ± 0.25 mV/40 kΩ
Mic	: 1.7 mV ± 0.25 mV/47 kΩ
Aux, tuner	: 240 mV ± 0.25 mV/10 kΩ
Tonband 1,2	: 210 mV ± 0.25 mV/15 kΩ

Für eine mehr detaillierte technische Spezifikation verweisen wir auf die kommerzielle Dokumentation.

(S)

Ingångssignal för 2 V per kanal vid 1 kHz

PU 1,2	: 2 mV ± 0.25 mV/40 kΩ
Mic	: 1.7 mV ± 0.25 mV/47 kΩ
Aux, tuner	: 240 mV ± 0.25 mV/10 kΩ
Rec. 1,2	: 210 mV ± 0.25 mV/15 kΩ

För mera detaljerade tekniska data se kommersiell dokumentation.

(SF)

Tulosignaali 2 V:lle per kanava 1 kHz:lla

Phono 1,2	: 2 mV ± 0.25 mV/40 kΩ
Mic	: 1.7 mV ± 0.25 mV/47 kΩ
Aux, tuner	: 240 mV ± 0.25 mV/10 kΩ
Nauhuri jne 1,2	: 210 mV ± 0.25 mV/15 kΩ

Yksityiskohtaisempia teknisiä tietoja tarvittaessa katso kaupallinen esite.

- 401 4822 256 40052
- 402 4822 276 10712
- 403 4822 255 40154
- 404 4822 267 30313
- 406 4822 426 50326
- 407 4822 276 30252
- 408 4822 410 22099
- 409 4822 413 30795
- 411 4822 410 22111
- 412 4822 413 40816
- 413 4822 413 40815
- 414 4822 146 30322
- 415 4822 256 30154
- 416 4822 267 50274
- 417 4822 267 40266
- 418 4822 267 50265
- 419 4822 273 50186
- 421 4822 276 40237
- 422 4822 276 40238
- 423 4822 276 30251
- 424 4822 426 40155
- 426 4822 267 30314
- 428 4822 462 71111

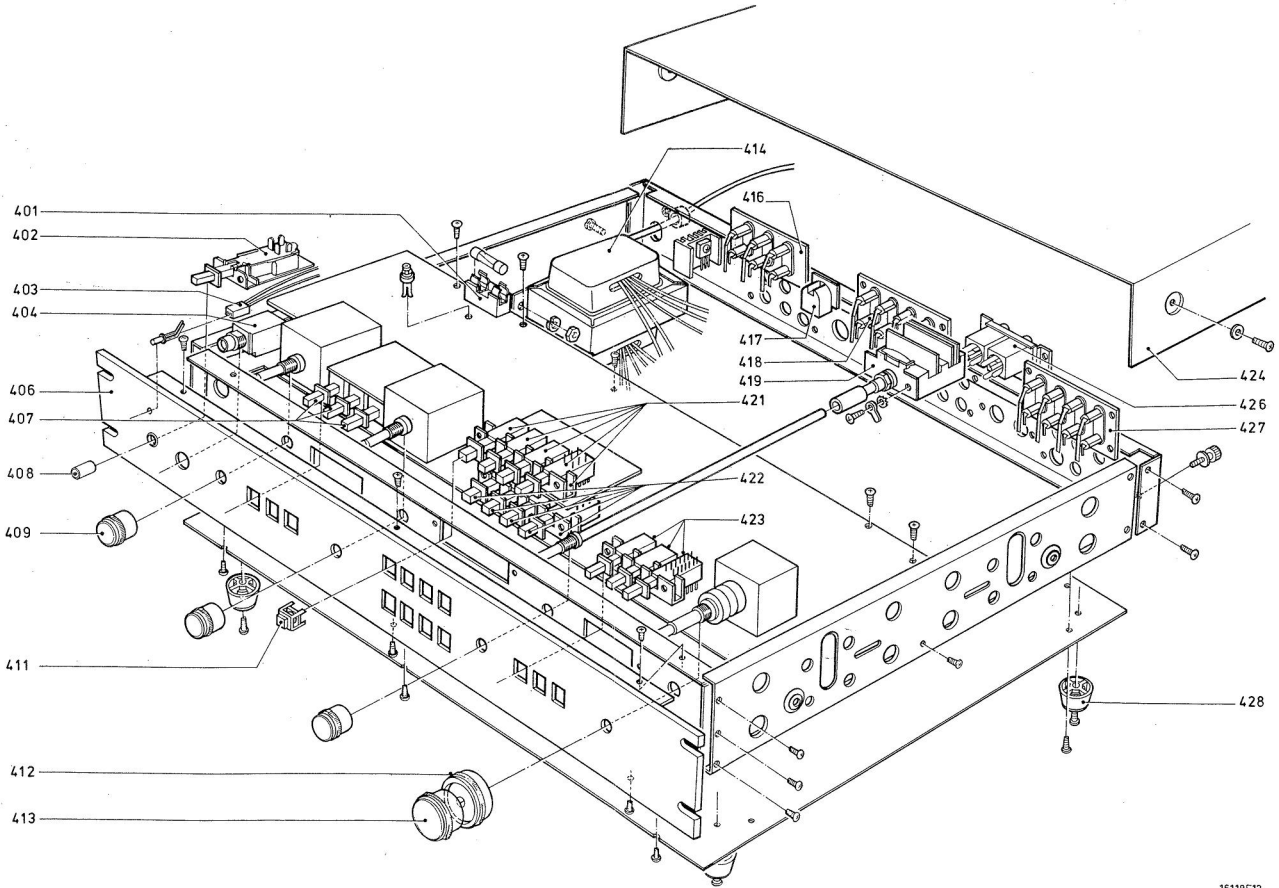

16118E12

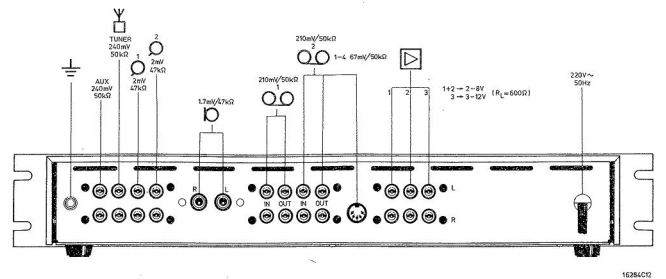
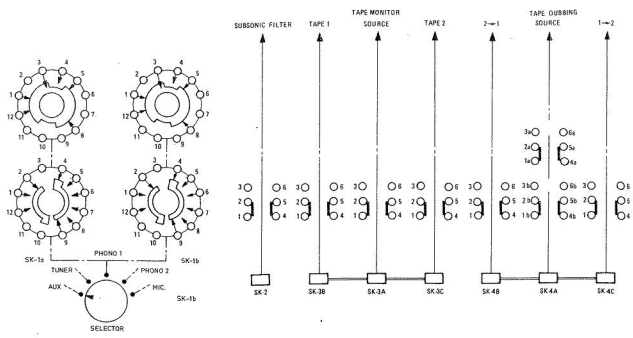

SK-16/18 CONTACTS

4	AUX
5	TUNER/ADAPTEUR
6	PHONO 1
7	PHONO 2
8	MIC
9	COMMON/COMMUN
12	PHONO 1
1	PHONO 2
2	COMMON/COMMUN
3	COMMON - GROUND COMMON - TERRE

• THE CIRCUIT HAS BEEN DRAWN IN POSITION "AUX"; TUNOVERS: 500Hz AND 2.5kHz
 • LE CIRCUIT EST DESSINE EN POSITION "AUX"; POINTS CHARNIERE: 500Hz ET 2.5kHz

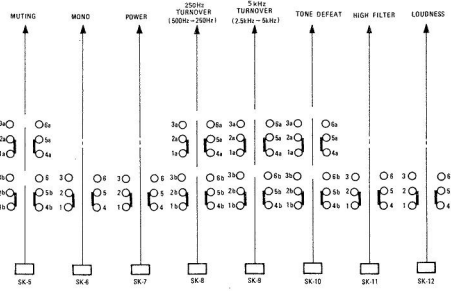

16285D12

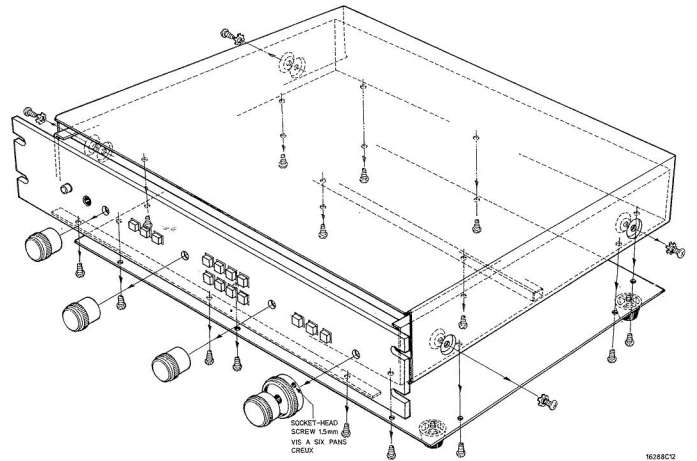

16288C2

* TO BE MOUNTED FROM ABOVE THE PRINT
MONTÉ EN HAUT AU DESSUS DE LA PLATINE

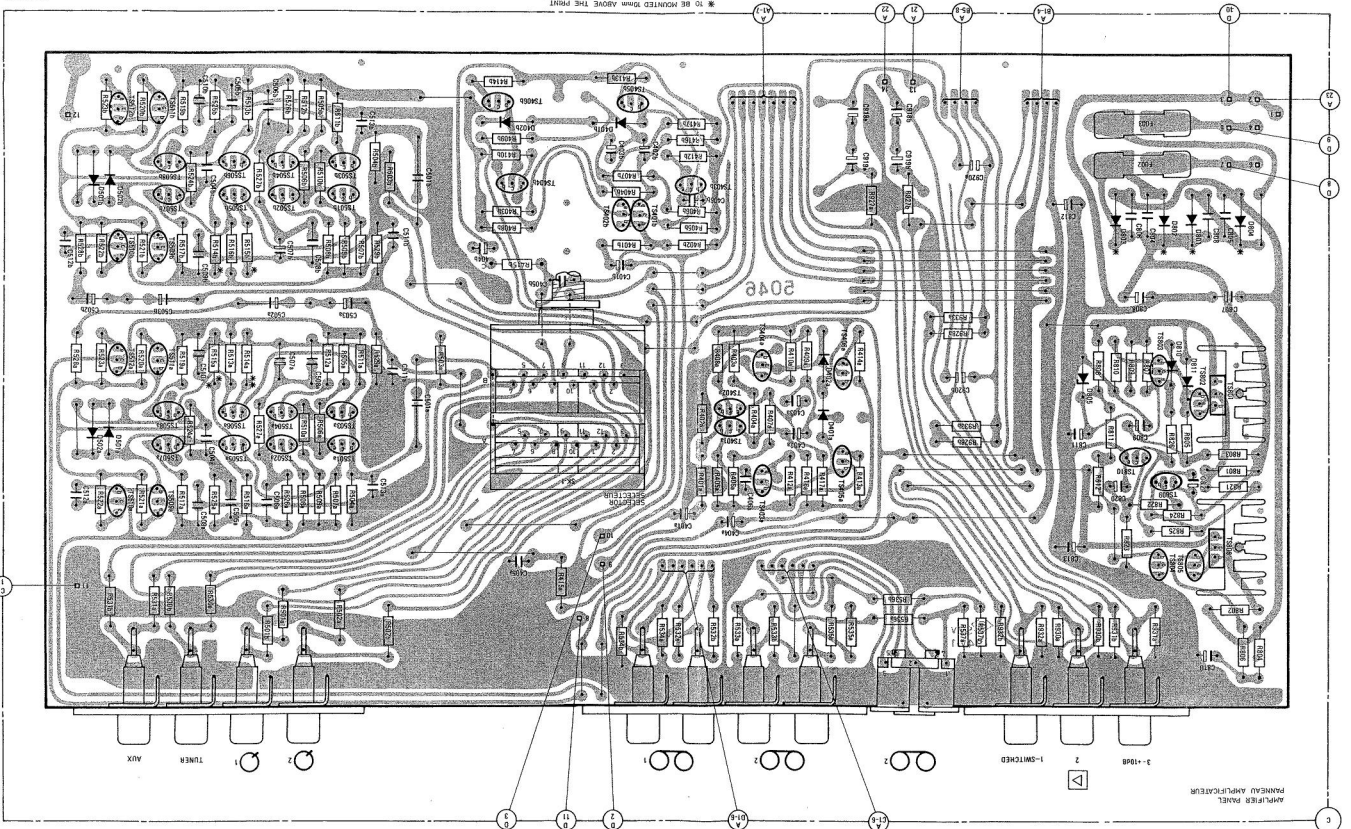

M	15881 - 15888	15889 - 15896	15897 - 15904	15905 - 15912	15913 - 15920	15921 - 15928	15929 - 15936	15937 - 15944	15945 - 15952	15953 - 15960	15961 - 15968	15969 - 15976	15977 - 15984	15985 - 15992	15993 - 16000	16001 - 16008	16009 - 16016	16017 - 16024	16025 - 16032	16033 - 16040	16041 - 16048	16049 - 16056	16057 - 16064	16065 - 16072	16073 - 16080	16081 - 16088	16089 - 16096	16097 - 16104	16105 - 16112	16113 - 16120	16121 - 16128	16129 - 16136	16137 - 16144	16145 - 16152	16153 - 16160	16161 - 16168	16169 - 16176	16177 - 16184	16185 - 16192	16193 - 16200	16201 - 16208	16209 - 16216	16217 - 16224	16225 - 16232	16233 - 16240	16241 - 16248	16249 - 16256	16257 - 16264	16265 - 16272	16273 - 16280	16281 - 16288	16289 - 16296	16297 - 16304	16305 - 16312	16313 - 16320	16321 - 16328	16329 - 16336	16337 - 16344	16345 - 16352	16353 - 16360	16361 - 16368	16369 - 16376	16377 - 16384	16385 - 16392	16393 - 16400	16401 - 16408	16409 - 16416	16417 - 16424	16425 - 16432	16433 - 16440	16441 - 16448	16449 - 16456	16457 - 16464	16465 - 16472	16473 - 16480	16481 - 16488	16489 - 16496	16497 - 16504	16505 - 16512	16513 - 16520	16521 - 16528	16529 - 16536	16537 - 16544	16545 - 16552	16553 - 16560	16561 - 16568	16569 - 16576	16577 - 16584	16585 - 16592	16593 - 16600	16601 - 16608	16609 - 16616	16617 - 16624	16625 - 16632	16633 - 16640	16641 - 16648	16649 - 16656	16657 - 16664	16665 - 16672	16673 - 16680	16681 - 16688	16689 - 16696	16697 - 16704	16705 - 16712	16713 - 16720	16721 - 16728	16729 - 16736	16737 - 16744	16745 - 16752	16753 - 16760	16761 - 16768	16769 - 16776	16777 - 16784	16785 - 16792	16793 - 16800	16801 - 16808	16809 - 16816	16817 - 16824	16825 - 16832	16833 - 16840	16841 - 16848	16849 - 16856	16857 - 16864	16865 - 16872	16873 - 16880	16881 - 16888	16889 - 16896	16897 - 16904	16905 - 16912	16913 - 16920	16921 - 16928	16929 - 16936	16937 - 16944	16945 - 16952	16953 - 16960	16961 - 16968	16969 - 16976	16977 - 16984	16985 - 16992	16993 - 16996
---	---------------	---------------	---------------	---------------	---------------	---------------	---------------	---------------	---------------	---------------	---------------	---------------	---------------	---------------	---------------	---------------	---------------	---------------	---------------	---------------	---------------	---------------	---------------	---------------	---------------	---------------	---------------	---------------	---------------	---------------	---------------	---------------	---------------	---------------	---------------	---------------	---------------	---------------	---------------	---------------	---------------	---------------	---------------	---------------	---------------	---------------	---------------	---------------	---------------	---------------	---------------	---------------	---------------	---------------	---------------	---------------	---------------	---------------	---------------	---------------	---------------	---------------	---------------	---------------	---------------	---------------	---------------	---------------	---------------	---------------	---------------	---------------	---------------	---------------	---------------	---------------	---------------	---------------	---------------	---------------	---------------	---------------	---------------	---------------	---------------	---------------	---------------	---------------	---------------	---------------	---------------	---------------	---------------	---------------	---------------	---------------	---------------	---------------	---------------	---------------	---------------	---------------	---------------	---------------	---------------	---------------	---------------	---------------	---------------	---------------	---------------	---------------	---------------	---------------	---------------	---------------	---------------	---------------	---------------	---------------	---------------	---------------	---------------	---------------	---------------	---------------	---------------	---------------	---------------	---------------	---------------	---------------	---------------	---------------	---------------	---------------	---------------	---------------	---------------	---------------